



HOMEBOT
— IRELAND —

dottie

ROBOT VACUUM AND MOP

User Manual

Please read the user manual carefully before use and keep it properly.

Welcome

Welcome to your Dottie Robot Vacuum Cleaner.

We encourage everyone to give their robot a name, for help with set up please call HomeBot Ireland 021-4742327.

*** Specific product details may differ from those shown here.**

Table of Contents

1. Safety Instructions	Important Safety Instructions	001
	2.1 What's in the Box	004
2. Product Overview	2.2 Product Anatomy(including Buttons and Indicators)	005
	3.1 Important Tips Before Use	008
3. Installation	3.2 Get Started	008
	4.1 Main Functions	011
	4.2 Mopping Function	013
4. Operation Instructions	4.3 Network Functions	015
	4.4 Other Functions	015
	5.1 Routine Maintenance	016
5. Maintenance and Troubleshooting	5.2 Troubleshooting	020
	5.3 FAQs	023
	Basic Parameters	025
6. Declarations	Energy Saving and Battery	026
	Customer Service	027

1. Safety Instructions

Before using the product, please follow the following basic safety precautions:

- Read all the contents of the manual carefully and follow the steps indicated in the manual to use the product.
- Keep the manual safe for future reference.
- If you need to transfer the product to a third party for use, please enclose the instruction manual with the product.
- Any operation inconsistent with the instructions in the instruction manual may cause serious personal injury or damage to the product itself.
- If the instruction manual is lost, please contact the local dealer or contact the customer service to obtain the electronic version of the instruction manual.

Important Safety Instructions

Use Restrictions

- This product may not be used by persons with physical, sensory, mental or intellectual disabilities and those without relevant experience and knowledge, including children, unless supervised or instructed by a guardian to ensure that they can use this product safely.
- Do not allow children to use the product as a toy. Please supervise children and pets to keep them away as far as possible when the product is working. Do not use the product in the room where infants sleep unattended.
- This product may contain small parts and accessories. Please keep the product and accessories out of the reach of children, so as to prevent children from accidentally disassembling or damaging the product or its accessories, or swallowing small parts, which may cause suffocation or other dangers.
- Children are forbidden to play with the product bags as this may lead to suffocation.
- Do not place the roller brush cleaning tool in an area where children can reach it.

- This product is only used for floor cleaning in the home environment. Do not use it outdoors (such as open balconies), non-floor (such as sofas), commercial or industrial environments.
- Do not use the product in suspended environments (such as duplex floors, open balconies, furniture tops) without protective fences.
- Before use, please hang up the ground cable at home to avoid dragging the cable when the robot is running.
- Please put away the fragile articles and sundries (such as vases, plastic bags, etc.) on the ground to avoid the damage of valuables in the house caused by the obstruction of the robot in operation or slight collision.
- The charging base should be placed against the wall and in a flat area, kept away from open fire, heat sources, water, narrow area or areas where the robot may be suspended, so as to prevent the function of the product from being affected.
- If you move the charging base while the robot is in operation it will not find its way home to charge.

- Do not use above 40 ° C, below 0 ° C or in the presence of any liquid or viscous substances on the floor.
 - Do not use the product in a humid environment (such as a bathroom, etc.)
 - Do not use the product to clean burning objects (such as unextinguished cigarette butts, etc.) and flammable and explosive objects (such as lighters, gasoline, color matching agent and toner used in printers or copiers, etc.).
 - Do not use the product for cleaning shag carpets (some dark colored carpets may not clean properly).
 - Do not let the product absorb hard or sharp objects (such as decoration waste, glass, nails, etc.), otherwise the robot and the ground may be scratched.
 - Before cleaning the entire house, it is recommended that a local area test is performed in your home to ensure that the product will not scratch or damage the floor.
-
- When the robot is working, pay attention to keeping the hair, fingers and other parts of the human body or pets away from the dust suction port or the rotating position of the brush head of the robot to avoid injury.
 - Do not put any objects such as children and pets on the stationary or moving product. Do not sit or stand on the robot and charging base.
 - To prevent knocking down, please inform other people in the room when this product is operating.
-
- Do not invert the product when placing it. Do not use the cover plates such as the front cover, the front bumper, and the laser ranging sensor protection cover as handles for handling.
 - Please clean or maintain the robot and charging base in the state of shutdown or power-off. · Do not touch the power plug or the product when your hands are wet, otherwise this may cause electric shock.
 - Do not wipe or rinse any part of the product except the washable parts with a wet cloth or any liquid, and after daily cleaning, the washable parts should be fully dried before installation and use.
-
- Please use this product according to the instruction manual. Any loss and injury caused by improper use shall be borne by the user.
 - Please do not use the product if the robot and accessories of the product are damaged. Contact the customer service department on 021-4742327. This product shall not be disassembled, repaired, or modified by anyone other than our designated or authorized service technicians.

Battery and Charging

- Do not use batteries, adapters or power cords, charging bases of any third-party. This product can only be used with the battery, adapter, or power cord and charging base supplied with the robot. Failure to do so, product damage, electric shock, or fire due to high voltage may be resulted in.
- It is forbidden to disassemble, repair or modify the battery or charging base without permission.
- Do not place the charging base near a heat source, such as heating radiator.
- Do not touch wires, sockets, or power adapters with wet hands.

- Do not wipe or clean the charging contacts with a damp cloth or wet hands.
 - If the power cord is broken or fractured, please stop using it immediately and purchase or replace it through official channels.
 - If you need to transport this product, please make sure that the robot is turned off, and it is recommended to pack it in the original packaging box.
 - If the product is not used for a long time, please turn off the robot after it is fully charged and put it in a cool and dry place. Charge it at least once every three months to avoid over discharge of the battery.
 - Please use it under the condition that the power supply voltage conforms to the voltage value marked on the charging base. If the use area is vulnerable to thunderstorms or unstable power supply voltage, it is recommended to take appropriate protective measures.
 - It is prohibited to use with any type of power converter, otherwise the warranty will become invalid immediately, and danger may occur.
-
- In case it is required to replace the robot battery, please contact our customer service department. If the wrong type of battery is used for replacement, it may cause a safety accident.
 - In case of battery leakage, be careful not to let the liquid stick to the skin or clothes. Wipe it immediately with a dry cloth and send it to the recycle bin or designated maintenance point. Do not discard it indiscriminately.
 - Turn off the power switch before removing the battery.
 - The battery must be removed when scrapping this product. Please dispose of the old batteries properly, and do not discard the waste battery at will. Batteries contain harmful substances that are harmful to the environment. Please put them into the specified recycle bins according to the local environmental protection regulations.

Laser safety information

- This laser distance sensor complies with the class 1 laser product standard of IEC 60825-1:2014 and does not emit dangerous laser radiation. However, for better safety, please avoid your family (especially children and pets) from looking directly at the laser emitter at close range.

2. Product Overview

2.1 What's in the Box

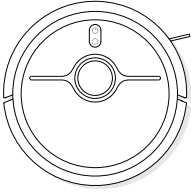

Robot Vacuum
(Robot)

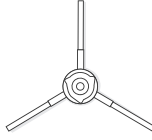

Side Brush (x1)



Cleaning Brush
(Built in the Robot's dust box)

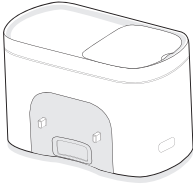

Auto-empty Charging Base
(Charging Base)
(with dust bag pre-installed)

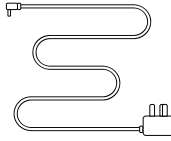

Power cord

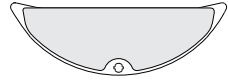

Mopping combo module
(Mop installed)

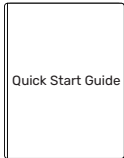

Quick Start Guide

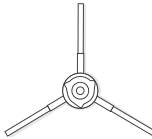

Additional
Side Brush (x1)

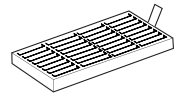

Additional Filter (x1)

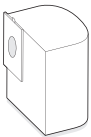

Additional Dust Bag (x1)

2.2 Product Anatomy (including Buttons and Indicators)

A) Robot Vacuum

Top View

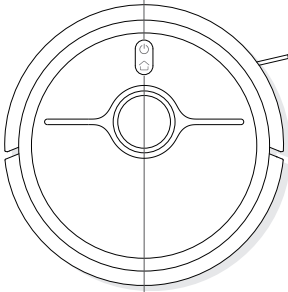

Button

⏻ Power button

- **Turn On/Off** : Press and hold for 3 seconds to power on or off. - **Auto Cleaning** : After power-on, press to start Auto Cleaning.

🏠 Recharge button

- **Recharge** : Press to start recharging. - **Manual Emptying**: Press to start manual dust collection during charging.

⏻ + 🏠

- **Reset Wi-Fi** : Press and hold both buttons for 3 seconds to reset Wi-Fi.

* Press any button to pause during cleaning or recharging.

Robot status indicator light

White : Normal power

Orange : Low power **Red** : Error

Pulsing White/Orange : Charging

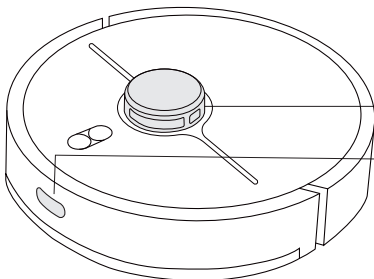
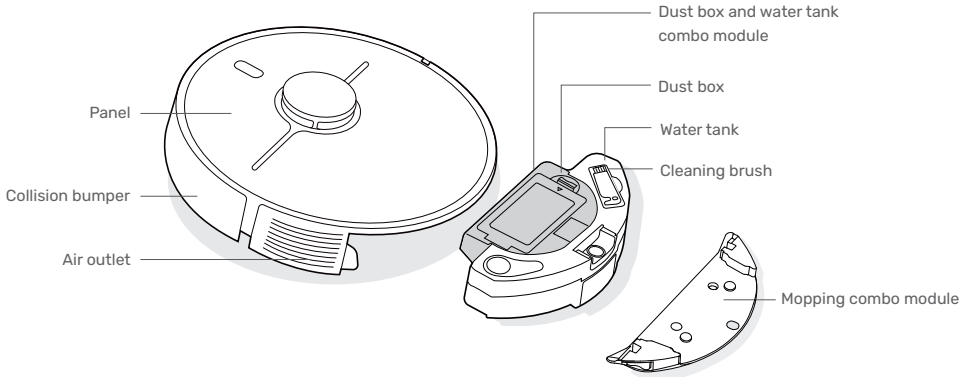

Main sensors

Laser distance sensor

Recharge sensor

Bottom View

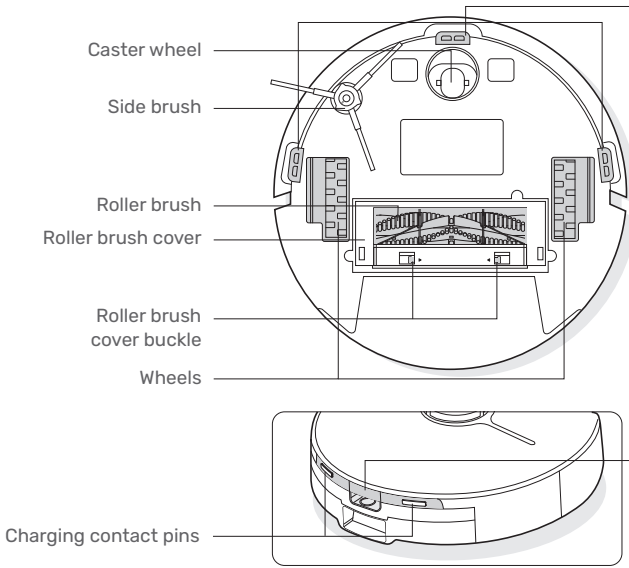

Main sensors

- Cliff sensor
- Recharge sensor

Dust Box and Water Tank Combo Module

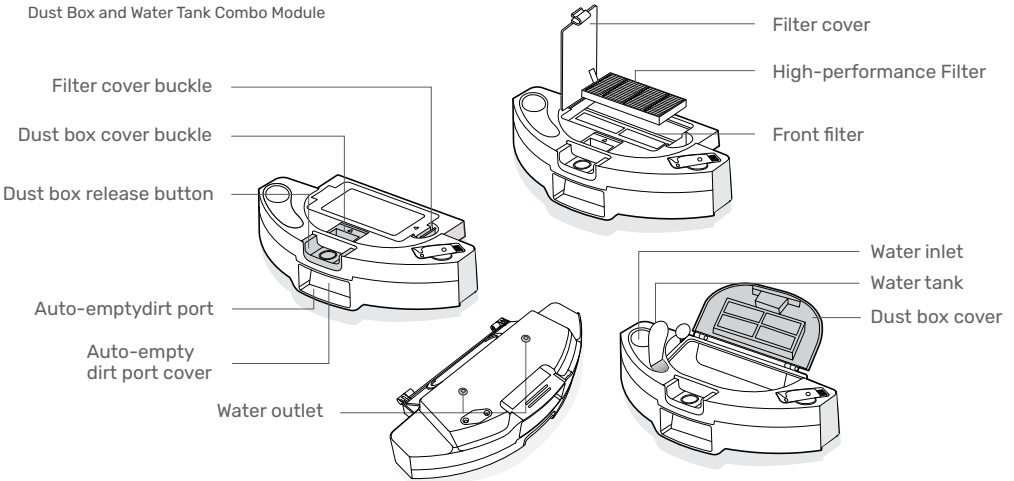

Mopping combo module

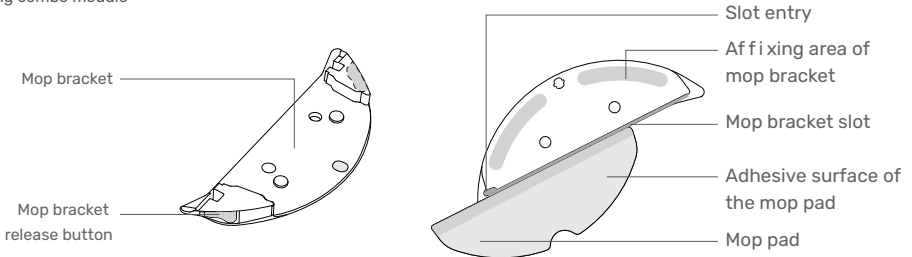

Auto-Empty Charging Base (referred to as the Charging Base)

Front View

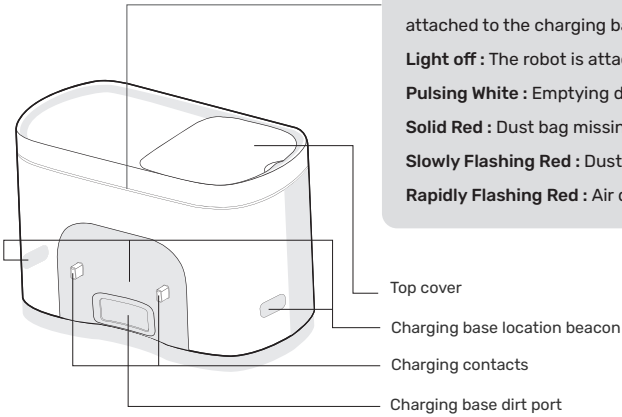

Status indicator light (in power-on state)

Solid White : Connected to power, but the robot is not attached to the charging base.

Light off : The robot is attached to the charging base.

Pulsing White : Emptying dust.

Solid Red : Dust bag missing or top cover not close tightly.

Slowly Flashing Red : Dust bag needs to be replaced.

Rapidly Flashing Red : Air duct blocked.

Back View

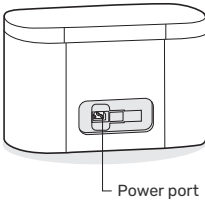

Top View

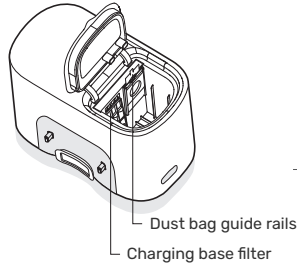

Bottom View

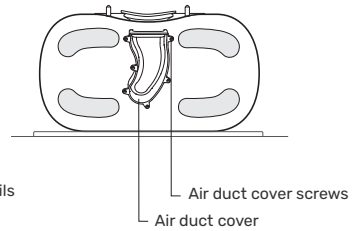

3. Installation

3.1 Important Tips Before Use

Prepare your home environment

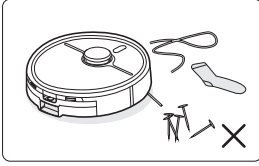

- 1 Clean up any debris or wires on the floor that may entangle the Robot before use, and remove easily fallen, fragile, valuable, and potentially hazardous items. Avoid personal or property damage caused by being entangled, stuck, dragged or knocked down by the robot.

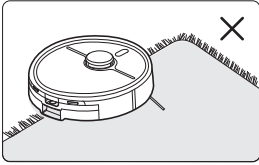

- 2 Fold the fringed edge of the decorative carpet underneath to prevent it from entangling the Robot. Avoid carpets that are very dark in color or thicker than 12.7mm.

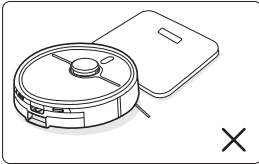

- 3 The robot may climb on top of objects less than 20mm in height. Remove these objects if possible.

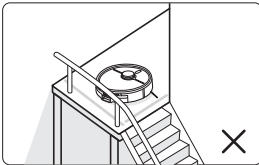

- 4 If the Robot is used in a suspended environment or a dangerous area such as a fireplace or an exhaust port, please use a solid physical barrier to prevent the robot from accidentally falling or entering to cause personal or property damage.

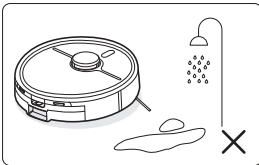

- 5 Make sure the Robot is kept away from wet areas and viscous substances during cleaning.

- 6 Please observe the robot patiently and assist in dealing with some minor problems during the first few runs of the robot. During the first run, you may encounter some situations that require additional adjustment, such as getting stuck or avoiding clean places, which will make the robot run more smoothly in the future.

3.2 Get Started

1) Remove protective items

Before use, please remove the protective strip or film on the robot to ensure the normal usage.

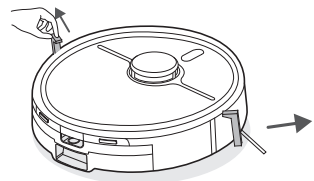

2) Install side brush

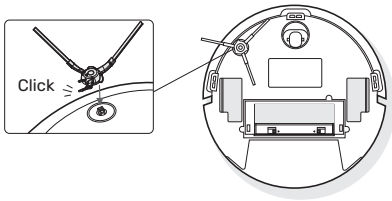

3) Place the charging base, connect the power supply and charge the robot

- 1) Connect the power cable and organize the power cables with the cable ties.

Note:

- Power cable on your floor may entangle the robot, resulting in power failure or jamming of the robot.

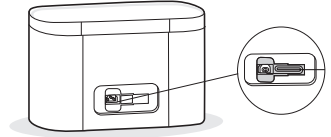

- 2) Place the charging base and power it on.

- Place the charging base in an easy-to-access position for the robot.

Note :

- Ensure that no objects are placed within 1.5m in front of the charging base and 0.5m from both sides.
- Do not cover the signal transmitting area of the charging base with any object.
- Avoid direct sunlight, which will affect the recharge effect.

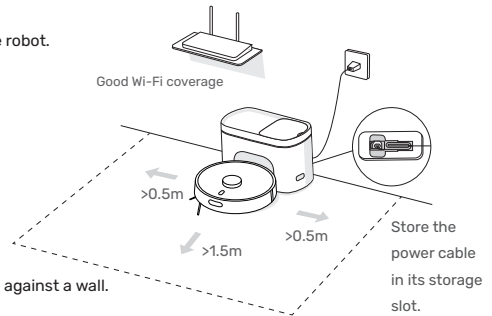

- Place the charging base on a level, non-slip, hard surface and against a wall.

Note :

- To avoid recharging failure caused by position change, do not put the charging base on a carpet or blanket.

- Always connect the charging base to the power supply. Ensure that it is located in a place with continuous Wi-Fi network and good network performance.

Note :

- Always keep the charging base plugged in, otherwise the robot will not return automatically.
- To return to the charging base smoothly after cleaning, it is recommended to start cleaning from the charging base. Do not move the charging base during cleaning.

- 3) Connect the robot to the charging base and turn it on.

- After connecting to the power supply, attach the robot to the charging base by aligning the charging contact pins. The robot will turn on automatically.

Note :

- When the battery level is insufficient to turn on the robot, place the robot on the charging base for a period of time, and the device will turn on automatically.
- If the robot is not on the charging base, press and hold the power button for 3 seconds to turn it on.

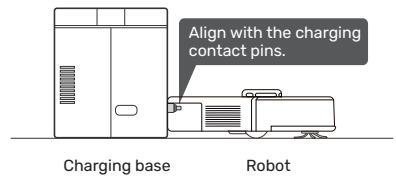

- 4) Fully charged.

- Fully charge the robot before first use.

Note :

- It is recommended to charge the robot for at least 4-6 hours before first use. The robot will not start or return for recharge without enough power.



4) Connect to mobile client

Note :



- Make sure your smartphone is running iOS 9.0 (or above) or Android 5.0 (or above).
- Make sure the 2.4GHz band wireless signal is enabled on your wireless router and the signal is strong. - To ensure better connection quality, please turn on the Bluetooth of your mobile phone.

1 Download the app.

- Search for the "Smart Life" app in the app store. Then download and install it.



2 Reset Wi-Fi.

- Press and hold both buttons ( Power button and  Recharge button) at the same time for 3 seconds until you hear the voice prompt. The two indicator lights of the robot start to flash slowly, indicating that the robot is ready for pairing.

3 Add a device.

- Open the app and follow the prompts to register or log in your account.
- Go to the home page of the app. Tap "+" in the upper right corner of the page to enter the "Add Device" page.
- Follow the on-screen instructions to connect with the robot.

Note :

- Only the 2.4GHz band is support for the Wi-Fi connection.
- Due to the upgrade of the application, the actual operation may be different from the above description. Please follow the instructions in the current application.
- If the network distribution fails, please reset the Wi-Fi and repeat the above operations.

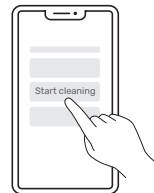
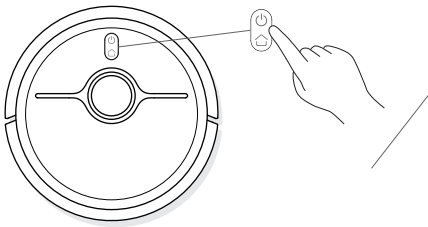

5) Start cleaning



4.Operation Instructions

4.1 Main Functions

● Turn on/off

- Press and hold  Power button for 3 seconds to turn on the robot. After the power indicator lights up for a period of time, the robot enters the standby state. Press and hold  Power button for 3 seconds to turn off the robot.

 **Note :**

- The robot cannot be turned off during charging.

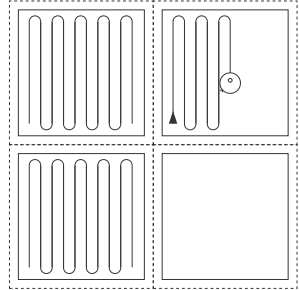

● Start Cleaning (Auto cleaning)

- Press  Power button to start cleaning. After startup, the Robot will leave the charging base to generate a map via auto scanning, intelligently determining its cleaning route and dividing the space into a number of areas. The Robot will carry out cleaning in an "arch" pattern following the identified cleaning route along the wall to complete cleaning in every area.

 **Note :**

- If the battery is too low to start cleaning, charge the robot first and then start cleaning.
- If the power is insufficient during the cleaning, the robot will automatically return to the charging base for charging. When the power is sufficient, the robot will resume cleaning from where it left off.
- Please tidy up all wires on your floor (including the power cable of the charging base) before cleaning to avoid recharge failure and damage to the items or wires caused by dragging during cleaning.
- Do not move the charging base during cleaning, and make sure that the charging base is connected to the power supply, otherwise the robot may not return normally.

● Pause/Resume/Sleep

- When the robot is working, press any button to pause it, and press  Power button to continue cleaning.
- If the standby exceeds 10 minutes, the robot will automatically enter the sleep mode. The indicator will turn off in the sleep mode. Press any button to wake up the robot in the sleep mode.

 **Note :**

- If the robot is put back to the charging base for charging, the cleaning task will be ended.
- When continuing to clean, please keep the robot to start in the original position and direction to avoid path disorder. The robot does not go to sleep while charging.
- Automatic shutdown when sleep time exceeds 6 hours.

● Recharge

- Auto mode: When the cleaning is finished or the battery is insufficient, the robot will automatically return to the charging base for charging.
- Manual mode: In the pause mode, press  Recharge button to start recharging, or the mobile phone client commands recharging.

 **Note :**

- If the device does not find the charging base, please manually put the robot back to the charging base for charging.
- The indicator light will pulse white or pulse orange when the device is charging.

● Map management

- Create a Smart Map:
 - When there is no map at the beginning of the cleaning task (such as the first cleaning, after resetting the smart map, etc.), the robot will create a new smart map. In order to generate a complete floor plan, please follow the following operations:
 - Open the door for robot to map each room in auto cleaning task. -
 - Remove any objects that may be blocking or jamming the robot.
 - Do not move the charging base or disconnect the power supply after smart map created.

Real-time Mapping

- Real-time Mapping helps you know the cleaning path and environment easily. A smart map will be built after cleaning. The smart map will be updated in real time during each cleaning to ensure normal navigation.

Relocalize and Remap:

When the location of the robot or charging base is moved or the surrounding environment changes significantly, the robot will attempt to relocalize and possibly remap to match the surrounding environment. The details are as follows:

- If the relocalize is successful, the robot resumes cleaning.
- If the relocalize fails in spot cleaning, zone cleaning, and room cleaning modes, the robot will terminate the task.
- If the relocalize fails in the auto cleaning mode, the robot will remap to ensure providing normal navigation for the new cleaning, but the map setting information such as no-go zone and room dividers will be lost.

⚠ Note :

- Make sure that the robot starts each cleaning from the charging base.
- Do not move the robot frequently during cleaning. If moved, place the robot back to its original location.

● Spot cleaning (only set via the app)

- Use the remote control page of the app to start the spot cleaning. The robot will clean a rectangular area of 1.5m x 1.5m with itself as the center. After the cleaning, the robot will automatically return to the starting point.

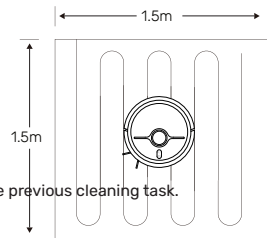

⚠ Note :

- Start spot cleaning when there are other tasks, which will directly end the previous cleaning task.

● Zone cleaning (only set via the app)

- Using the app, you can set one or more temporary zone on the smart map for zone cleaning. The robot will clean the set zone and automatically return to the charging base after cleaning.

⚠ Note :

- To use this function, you need to finish creating the smart map on the robot before you can use zone cleaning function.
- After starting cleaning, the robot may enter the area outside the designated area. Please pay attention to clearing the ground obstacles around the designated area. This function can not play a role of safety isolation.

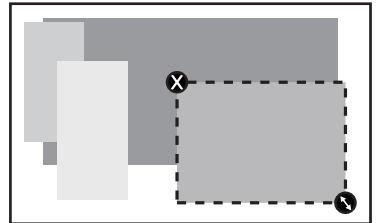

● Room cleaning (only set via the app)

- Using the app, you can select one or more rooms on the smart map for room cleaning. The robot will clean the selected rooms, and automatically return to the charging base after cleaning.

⚠ Note :

- To use this function, you need to finish creating a smart map on the robot and set the dividers before you can use the room cleaning function.
- After starting cleaning, the robot may enter the area outside the designated area. Please pay attention to clearing the ground obstacles around the selected area. This function can not play a role of safety isolation.

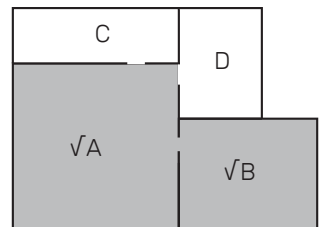

● Scheduled cleaning (only set via the app)

- You can schedule cleaning in the app. The robot will automatically start the task at the specified time and automatically return to the charging base after cleaning.

Note :

- ⚠ - When performing other cleaning tasks, if the scheduled cleaning is triggered, the previous cleaning task will be ended directly.

● Suction level (only set via the app)

- For best cleaning effect, select different suction levels according to your needs. - The greater the suction, the shorter the cleaning time and higher the noise.

● Auto-boost (only set via the app)

- During the cleaning, the robot will automatically increase the suction power if it detects that stronger power is needed to ensure the best clean, such as thick carpets and hard-to-clean messes.
- This function will reduce cleaning time and increase the noise level. If this function disturbs you, you can choose to turn off this function in the mobile client.

● Auto-empty dirt

- Auto emptying:
 - After cleaning, the robot will return to the charging base, and the robot will automatically empty the dust box according to the emptying frequency set in the app.
 - The emptying frequency can be adjusted in the app.
- Manual emptying :
 - When the robot is connected to the charging base, you can press the recharge button of the robot to start manual emptying.

⚠ Note :

- If auto emptying is not needed, disable this feature in the app.

4.2 Mopping Function

● Mopping

- Users may achieve mopping function by installing the mopping combo module and filling the dust box and water tank combo module with water.
- Once the mopping combo module is installed, the Robot will automatically activate its mopping function. Users can set the water flow rate on the mobile phone client and set mopping only during the cleaning process.

① Fill the water tank with water

- Remove the dust box and water tank combo module
- Unplug the water tank, and plug it back after refilling

⚠ Note :

- Do not use detergent and disinfectant to avoid corroding the water tank and blocking the outlet pipe.
- Filling with hot water is prohibited, which otherwise may lead to deformation of the water tank.

- Reinstall the dust box and water tank combo module

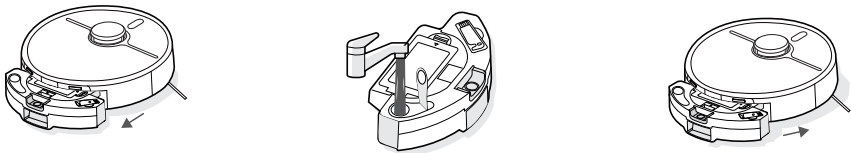

② Mop installation

- Wring out the fully soaked mop until no water drops. Place the mop bracket on the reverse side, insert the mop pad along the mop bracket slot. Then, fix the mop securely.

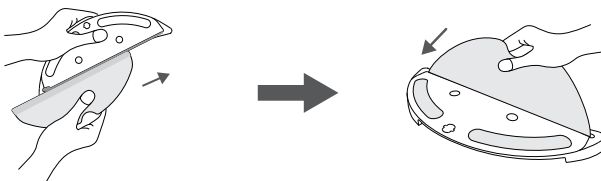

3 Install the mopping module

- Push the mopping module with the mop pad installed in parallel along the back of the Robot Vacuum, and install it in place when a "click" sound is heard.

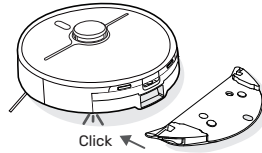

4 Start cleaning

- The mopping function is activated when starting cleaning task.

5 Remove the mopping module

- After Robot cleaning, press the pause key, and press the buttons on both sides and take out the mopping module backwards.

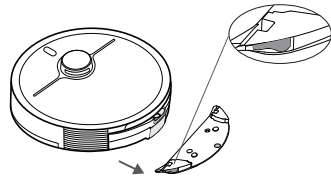
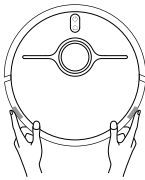

- After the Robot completes mopping, please remove the mop combo module and cleaning mop in a timely manner during charging or out of service, and also drain the water tank to avoid odor or mildew.

⚠ Note :



- Do not use the mopping function if the Robot is left unattended.
- Do not leave the wet mopping combo module at an area for a long time, which otherwise may lead to floor damage due to exposure to over-moisture.
- The Robot using the mopping combo module may operate at a less capability in overcoming the hurdle height. Thus, operators shall closely check for any jamming.
- The mopping function is only applicable to the clean floor without stubborn stains or liquid. If there are coffee stains, ink stains and other colored stains on the floor, do not use the mopping function to avoid floor contamination.
- The mopping function acts ideally on smooth and hard floors, and it may not work well on uneven tiles, floors covered with a lot of wax or rough surfaces. Under such circumstances, the Robot may not successfully complete mopping as it may be jammed or slid.
- It is prohibited to mop on the blanket.
- For the purpose of optimum mopping effect, it is advised to clean the floor with Robot 3 times before mopping.

● **Water flow rate adjustment**

- For the purpose of optimum mopping effect, users may set any water flow level on a case-by-case basis. - The higher the water flow level, the less time in completing mopping at one time.
- Closely check for water makeup for optimum mopping effect.

4.3 Network Function

● Reset Wi-Fi

- If your mobile phone cannot connect to the robot (such as configuration or password change of your router), try to reset Wi-Fi and reconnect to the network.
- Press and hold  Power button and  Recharge button at the same time for 3 seconds until you hear the voice prompt. The indicator light starts to flash slowly, indicating that the robot is ready for pairing.
- For detailed Wi-Fi setup instructions, refer to "Installation > Connect to mobile client" in this manual.

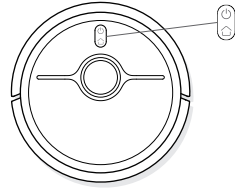

● Mobile client functions

- You can remotely control the robot through the mobile application.
- With the app, you can access more features such as scheduled cleaning, find my robot, reviewing the status, cleaning records, etc.
- For detailed Wi-Fi setup instructions, refer to "Installation > Connect to mobile client" in this manual.



Note :



- Due to the continuous development and upgrading of the app, functions and details may be slightly adjusted. Please refer to the actual version.

4.4 Other Functions

● Find my robot

- If the robot is stuck somewhere, you can find it through the "Find my robot" in the app.

● Force Restart system

- When the button does not respond or cannot be turned off, please try to restart the system.
- When not charging, press and hold  Power button for 10 seconds to force shutdown, and then press and hold  Power button for 3 seconds to turn on.

● Restore factory settings

- If the system cannot be used normally after restarting, please try to restore the factory settings.
- When not charging, press and hold  Recharge button for 15 seconds until the prompt tone is heard.
- The robot will clear all information and settings. At this time, the user needs to reconfigure the settings (including the network settings).

5. Maintenance and Troubleshooting

5.1 Routine Maintenance

Note: Please turn off and unplug the power cable before cleaning and maintaining the product .
For the best performance, refer to the following table for routine maintenance.

Parts	Maintenance frequency	Replacement frequency
Dust box	Monthly	-
Filter	Weekly	Every 3 months
Roller brush	Monthly	Every 6-12 months
Roller brush cover	Monthly	Every 3-6 months
Side brush	Monthly	Every 3-6 months
Water tank	After every use	-
Mopping combo module	After every use	-
Mop pad	After every use	Every 3-6 months (or badly worn)
Caster wheel	Monthly	-
Wheels	Monthly	-
Sensors	Monthly	-
Charging contact pins and charging contacts	Monthly	-
Dust bag	Monthly or sooner if the bag is full	Depending on the situation of full dust
Charging base filter	Monthly	-
Charging base dirt port	Monthly	-
Charging base air duct	In case of blockage	-



Note :

- If pets are kept, the frequency of parts maintenance should be increased to twice per cycle.
- The replacement frequency may vary depending on the actual situation. If visible or abnormal wear occurs, replace the parts.

1) Clean dust box and filter

- 1 Press the dust box release button to remove the dust box and water tank combo module.
- 2 Open and empty the dust box.
 - Use a cleaning brush to gently clean the inner cavity of the dust box, the front filter part.
- 3 Close the dust box cover, press the filter cover buckle to open the filter cover, and take out the filter.
- 4 Thoroughly rinse the filter with clean water.
- 5 Completely dry the filter and then put it back on.



Note :

- Be sure to dry the filter thoroughly before use to ensure normal operation and service life.
- Do not put the incomplete dust box into the robot, so as to avoid mistakenly triggering the cleaning, which will block the air duct of the robot or damage the fan.
- Do not touch or wash the dust box with water.

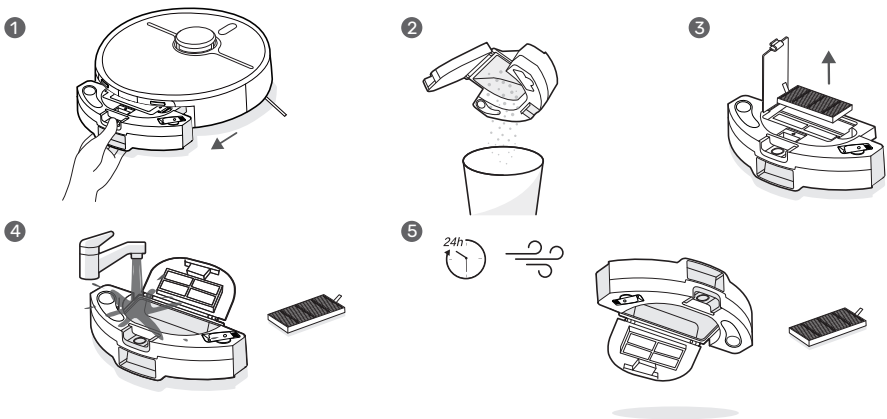

2) Water tank cleanup

- 1** Press the dust box release button to remove the dust box and water tank combo module.
- 2** Unplug the water tank and drain the tank.
- For further cleanup, refill and plug the tank, and shake the chamber inside the tank and drain water.
- 3** Dry the water tank and put it back.

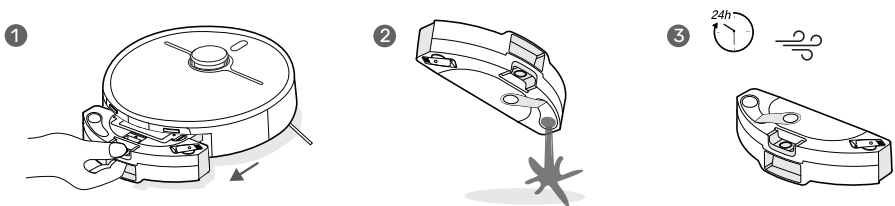

3) Mopping combo module cleanup

- 1** Press the mopping module buttons to take out the mopping module.
- 2** Remove the mop pad from the mop bracket.
- 3** Wash the mop pad and hang it to dry.

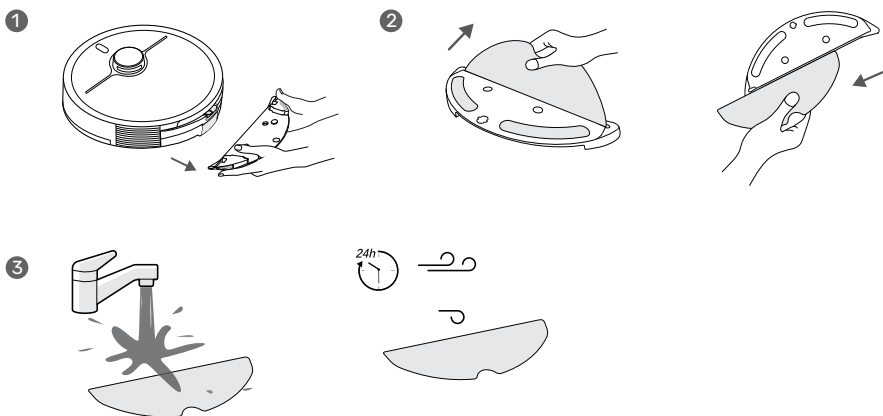

4) Clean roller brush and roller brush cover

- 1 Press and hold the roller brush cover buckle on both sides inward, and take out the roller brush cover and the roller brush.
- 2 Cut off the hair entangled on the roller brush with the blade of the cleaning brush.
- 3 The roller brush bearing on the side of the roller brush can be removed to clear any hair wound in the gap.
- 4 Clean the dirt on the roller brush cover.
- 5 Install the roller brush and roller brush cover back on.

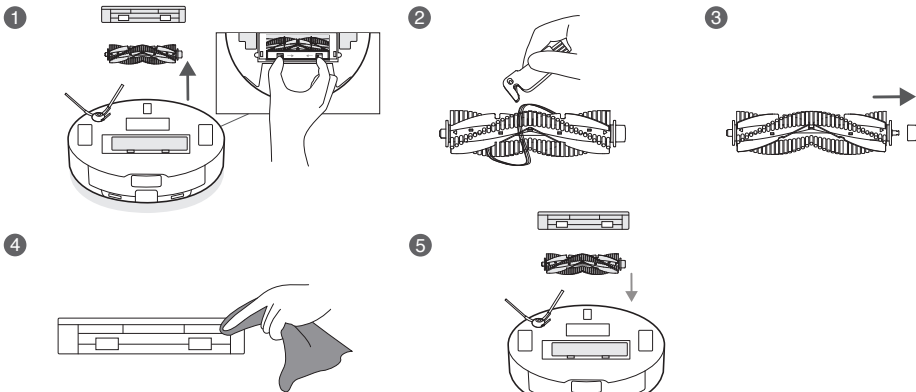

5) Clean the side brush

- 1 Pull out the side brush.
- 2 Clean the side brush with a cleaning brush and install it back.

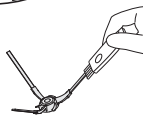

6) Clean caster wheel

- 1 Pry out the caster axle and pull out the caster body with a small screwdriver and other tools
- 2 Clean the hair and dirt from the caster axle and caster body, and then reinstall and press it tightly.

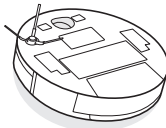
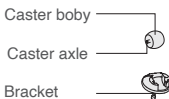

7) Clean wheels

- 1 Wipe and clean the wheels with a soft dry cloth.

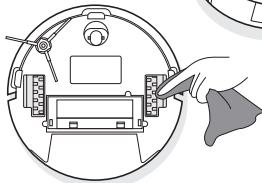

8) Clean sensors, charging contact pins and charging contacts

- 1 Wipe and clean with a soft dry cloth.



Note :

- There are sensitive electronic components inside the product, so please wipe them with a soft dry cloth when cleaning. Do not use wet rags to prevent water damage.

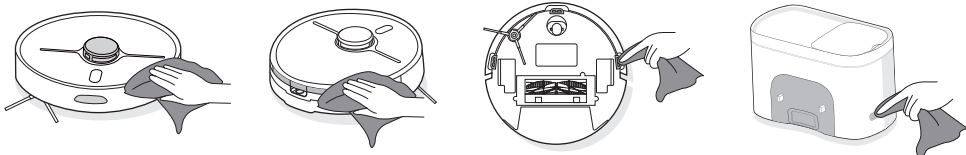

9) Replace dust bag of auto-empty charging base, and clean auto-empty dirt port and filter

When the dust bag is full, replace the dust bag according to the indicator light of the auto-empty charging base. It is recommended to check and replace the dust bag regularly.

- ① Open the top cover of the auto-empty charging base.
- ② Pull up the handle of dust bag to take out the dust bag.

⚠ Note :
- When taking out the dust bag, the clip of dust bag handle will automatically close the dust bag to effectively prevent dust leakage.

- ③ Discard used dust bags.
- ④ Wipe the filter inside the bucket and the auto-empty dirt port outside with a soft dry cloth.
- ⑤ Install a new dust bag, push the clip along the guide rail.
- ⑥ Close the top cover of charging base.

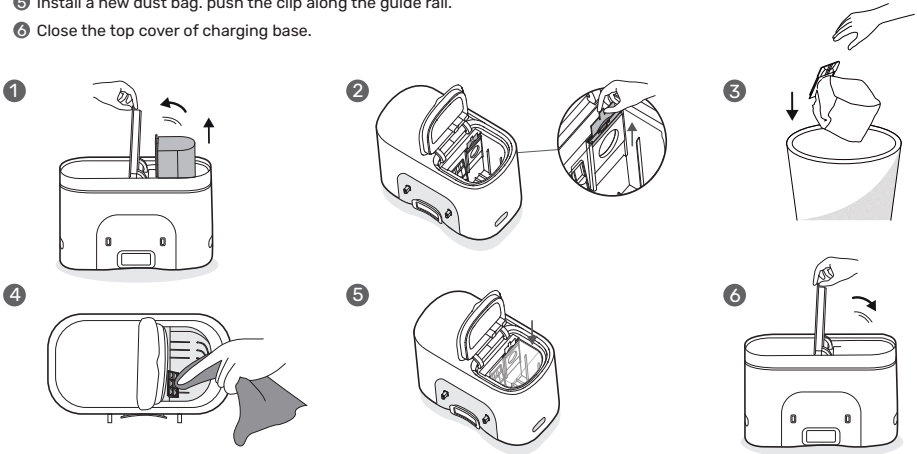

10) Clean the air duct

If the air duct is blocked, clean it according to the following steps.

- ① Put a soft cloth on a flat surface, and then lay the auto-empty charging base back and flat with the front side facing up.

⚠ Note :
- When taking out the dust bag, the clip of dust bag handle will automatically close the dust bag to effectively prevent dust leakage.

- Unscrew the air duct cover screws with a screwdriver and take out the air duct cover.
- Check whether the air duct is blocked by dirt and clean it.
- Reinstall the air duct cover back with a screwdriver.

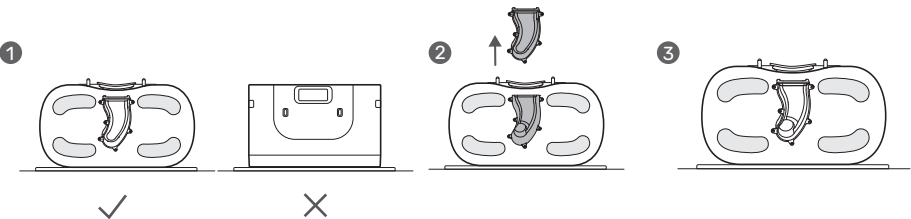

5.2 Troubleshooting

If an error occurs while the robot is working, the indicator light of the robot or the charging base will light up in red in different states with corresponding prompt sound. Please solve it by the following table.

Indicator light	Voice prompt	Solution
Robot - Flashing Red	Error 1: Front bumper stuck. Please clean and retry.	- The front bumper is stuck. Please tap repeatedly to remove any dirt. After confirmation, please relocate it to start.
	Error 2: Side brush stuck. Please clean and retry.	- The side brush may be entangled with trapped dirt. Please clean and retry.
	Error 3: Roller brush stuck. Please clean and retry.	- The roller brush may be entangled with trapped dirt. Please clean the roller brush and retry.
	Error 4: Wheel stuck. Please clean and retry.	- The wheel may be entangled with trapped dirt. Please clean the wheel and retry.
	Error 6: Filter blocked or wet. Please clean, dry and retry.	- The filter may be blocked or wet. Please clean it. If it is not dry, please dry it for at least 24 hours. If it cannot be solved, please replace the filter.
	Error 7: Wheel suspended. Please move it to near its original position and retry.	- The robot may be picked up or suspended, please move it to a new position close to the original position and retry.
	Error 8: Cliff sensor dirty. Please clean and retry.	- The robot is suspended in the air or the cliff sensor may be stuck with dirt or blocked. Please wipe the cliff sensor with a dry cloth and then move it to a nearby place to start.
	Error 10: Device tilted. Please put the robot on a flat surface to start.	- The robot is not on the level ground. Please put the robot on the level ground and retry.
	Error 11: Low Battery. The system is about to shut down. Please charge it.	- The battery power is low (less than 5%) and it is not on the charging base. Please charge the robot at the charging base.
	Error 12: Robot trapped. Please clear obstacles around.	- The robot may be stuck or trapped. Please clear obstacles around the robot.
	Error 13: Charging base blocked. Please clear it.	- The area around the charging base may be blocked by obstacles or dust. Please clean the area around and wipe the charging base location beacon area.
	Error 14: Charging error. Please wipe the charging contacts.	- Please wipe the charging contact pins of the robot and the charging contacts of the charging base with a dry cloth.
Error 15: Please insert the dust box and filter.	- Please insert the dust box and filter, and confirm that they are in place. If an error still occurs, please try to replace the filter.	

Indicator light	Voice prompt	Solution
Robot - Flashing Red	Error 16: Relocalized failed, stop cleaning.	- Please put the robot back to the charging base and restart it.
	Error 17: Relocalized failed, stop recharging.	- Please manually place the robot back to the charging base for charging.
	Error 18: The specified area cannot be reached.	- Please move the robot to a new location to start or remove the settings that robot cannot be crossed to the restricted area.
	Error 19: Laser distance sensor stuck. Please clean and retry.	- The laser distance sensor may be entangled with trapped dirt. Please clean and retry.
	Error 20: Laser distance sensor blocked. Please clear it	- The laser distance sensor maybe blocked by obstacles or dust. Please clean the area around and wipe it with a dry cloth.
	Error 21: No-go zone detected, move to new location to start	- Please move the robot outside the no-go zone and restart it.
	Error F1: Side brush module fault. Please check and try restarting the system.	- Please check whether side brush is entangled with dirt. Please remove, clean and reinstall the side brush, and then try to turn off and then turn on the system. - If the fault persists, please contact our customer service.
	Error F2: Roller brush module fault. Please check and try restarting the system.	- Please check whether the roller brush is entangled with dirt. Please remove, clean and reinstall the roller brush then try to turn off and then turn on the system. - If the fault persists, please contact our customer service.
	Error F3: Vacuum fan module fault. Please check and try restarting the system.	- Please check whether the dust box, filter or dust suction port is blocked by dirt. Please clear them, and then try to turn off and then turn on the system. - If the fault persists, please contact our customer service.
	Error F4: Wheel module fault. Please check and try to restart the system.	- Please check whether the wheel is entangled with dirt. Please clean it, and then try to turn off and then turn on the system. - If the fault persists, please contact our customer service.
Error F6: Battery module fault. Please wait until the battery temperature is normal before using.	- The battery temperature is too high or too low. Please wait for the battery temperature to be normal before use. - If the fault persists, please contact our customer service.	

Indicator light	Voice prompt	Solution
Robot - Flashing Red	Error F7: Laser distance sensor fault. Please check and try to restart the system.	<ul style="list-style-type: none"> - Please check whether the laser distance sensor are entangled with dirt. Please clean it, and then try to turn off and then turn on the system. - If the fault persists, please contact our customer service.
	Error F8: Water pump malfunction. Try to restart the system.	<ul style="list-style-type: none"> - Clean the water tank, water pump interfaces of water tank and Robot, and Robot base drain; check the mopping combo module. Then,try to shut off for restart up. - If the fault persists, please contact the sales service.
Charging base - Solid Red	Please check whether the dust bag is installed and close the cover properly.	<ul style="list-style-type: none"> - Please check whether the dust bag is missing, ensure that the dust bag is installed in place, and close the dust bag cover. - Please check the status of the dust bag cover to ensure that the dust bag cover is closed and sealed firmly.
Charging base - Flashing Red	Long time using dust bag, please replace the dust bag.	<ul style="list-style-type: none"> - Please check the status of the dust bag and replace the dust bag in time. If the dust bag is new, please take out the dust bag and reinstall.
	Air duct blocked. Please clean it.	<ul style="list-style-type: none"> - Please check whether the auto-empty dirt port of the robot and the auto-empty dirt port of the charging base are blocked. - If the above cannot be solved, refer to the chapter "Clean the air duct" to clean the air duct.

If the fault cannot be eliminated according to the above, please contact our customer service on 021-4742327.

5.3 FAQs

Problem type	Solution
Unable to turn on.	<ol style="list-style-type: none"> 1) Insufficient power. Please make sure that the charging base has been connected to the power supply, and then place the robot on the charging base and align with the charging contacts, and the device will automatically start up. 2) If it still cannot be started, please try to restart the system. When it is not charging, press Power button for 10 seconds to force the shutdown, and then press Power button for 3 seconds to start the system.
Unable to charge.	<ol style="list-style-type: none"> 1) Please remove the device and check whether the indicator light of the charging base is on. If not, please make sure that the power plug is plugged in correctly. (If the light is still not on, please contact customer service). 2) If the indicator light of the charging base is on, connect the powered robot to the charging base, and ensure that the charging contact pins of the robot is aligned with the charging contacts of the charging base. Check if the indicator light of the robot changes to the breathing state. 3) If the indicator light of the charging base is on and the robot is turned on, but the robot cannot be charged, please try to turn off the robot and pull out the charging base, wipe the charging contact pins of the robot and the charging contacts of the charging base with a soft dry cloth, and then try the above two steps again. (If the problem still exists, please contact the customer service).
Unable to start.	<ol style="list-style-type: none"> 1) Make sure that the robot is connected to the power supply. 2) Make sure the robot is fully charged. 3) Press and hold Power button for 3 seconds to turn on the robot.
Unable to recharge.	<ol style="list-style-type: none"> 1) Please clear the obstacles near the charging base and put the charging base in an open area. Please ensure that no objects are placed within 1.5m in front of the charging base and 0.5m on both sides. 2) Please use a soft dry cloth to wipe the infrared obstacle avoidance sensor, the recharge sensor, the charging base location beacon, the charging contact pins and charging contacts. 3) Please put the robot near the charging base.
Stop working suddenly.	<ol style="list-style-type: none"> 1) Check whether the robot is trapped or stuck by foreign matters. 2) Check whether the battery power is too low. 3) Check whether there is a red light or fault indication on the robot. Please refer to the chapter "Troubleshooting". 4) If the problem still can be resolved, please restart the system, long press Power button for 10 seconds to force the shutdown, and then press Power button for 3 seconds for starting up.

Problem type	Solution
Abnormal behavior.	<ol style="list-style-type: none"> 1) Please check whether there is corresponding fault prompt. Please refer to the chapter "Troubleshooting". 2) Wipe the sensor with a soft dry cloth. Refer to the chapter "Routine Maintenance". 3) Reboot the robot.
The robot suddenly made a loud noise.	<ol style="list-style-type: none"> 1) Please adjust the suction or turn off the auto-boost to see if this setting causes the more noise. 2) Please check whether the roller brush, filter, dust box, dust suction port, wheel and caster wheel are blocked by foreign matters. 3) Please ensure that the filter, roller brush and roller brush cover are installed in place.
Decreased cleaning performance or dust falling.	<ol style="list-style-type: none"> 1) Please clean the dust box. 2) Please clean or replace the filter. 3) Please clean the roller brush. <p>Refer to the "Routine maintenance" section for specific methods.</p>
The roller brush does not rotate.	<ol style="list-style-type: none"> 1) Please clean the roller brush and both ends of the roller brush, and check whether there are hairs and foreign matters. 2) Check whether the roller brush and roller brush cover are installed correctly.
The water in mopping combo module does not flow out or flow less.	<ol style="list-style-type: none"> 1) Please check whether there is water in the water tank and whether the mopping combo module is installed correctly according to the instructions. 2) Please use the APP on mobile to adjust the water flow to a high level. 3) Check whether the water outlet at the bottom of the water tank and the air return hole next the Water filling nozzle are blocked.
Unable to connect Wi-Fi.	<ol style="list-style-type: none"> 1) Make sure the robot is in a good Wi-Fi coverage area. 2) Please download the latest mobile phone client and reset Wi-Fi to try to connect again. 3) Please check whether the password is entered incorrectly or there are special characters in the password. 4) Please check whether the 5G frequency band network is connected. This robot only supports 2.4G frequency band.
Scheduled cleaning is not performed.	<ol style="list-style-type: none"> 1) Please check whether the electric quantity is $\geq 15\%$, and the regular cleaning can be started only when the electric quantity is $\geq 15\%$. 2) Please check whether the regular cleaning cycle is set correctly. 3) Please check whether the scheduled cleaning is successful. Try to make an appointment on the mobile phone client again. When the appointment is successful, the robot will report the prompt tone.

If the fault cannot be eliminated according to the above, please contact our customer service. The problems you encounter are also what we are concerned about and hope to help you solve.

6. Declarations

Basic Parameters

Robot Vacuum and Mop	
Product name	Robot vacuum
Product model	Dottie
Rated voltage	14.76V $\overline{\text{---}}$
Input power	24V $\overline{\text{---}}$ 1A
Rated power	30W
Charging time	<6 hours
Wireless connection	Wi-Fi IEEE 802.11b/g/n 2.4GHz

Auto-empty charging base	
Product name	Auto-empty charging base
Product model	SD10
Rated input	100V~
Rated output	24V $\overline{\text{---}}$ 1.5A MAX
Rated frequency	60HZ
Power	950W

Robot Vacuum and Mop	
Product name	Robot vacuum
Product model	S210
Rated voltage	14.76V $\overline{\text{---}}$
Input power	24V $\overline{\text{---}}$ 1A
Rated power	30W
Charging time	<6 hours
Wireless connection	Wi-Fi IEEE 802.11b/g/n 2.4GHz



Auto-empty charging base	
Product name	Auto-empty charging base
Product model	SD11
Rated input	220V~

Auto-empty charging base	
Rated output	24V  1.5A MAX
Rated frequency	60HZ
Power	950W

Apple, the Apple logo, and iPhone are trademarks of Apple Inc., registered in the U.S. and other countries. App Store is a service mark of Apple Inc., registered in the U.S. and other countries. Google, Google Play, the Google Play logo, and Android are trademarks of Google LLC. Amazon, Alexa, and all related logos are trademarks of Amazon.com, Inc. or its affiliates.

Energy Saving and Battery

Holiday energy saving mode

- On the charging base, press and hold  Recharge button for 10 seconds until a tone is heard, at which time the holiday energy saving mode is activated.
- Under the holiday energy saving mode, the network, scheduling and other functions will be turned off, and the robot will enter the low-power mode to save energy. 
- The function is ended only when the robot is moved out of the charging base or any button is pressed.

Remove the battery (for disposal)

- This is for discarding of the product and is not a daily operating instruction
- The chemical substances contained in the built-in lithium-ion battery of this product may cause pollution to the environment. Please remove it before scrapping and hand it over a professional battery recycle bin for centralized treatment.

1. Allow the robot to run to a low battery state that cannot be cleaned without touching the charging base.
2. Press and hold Power button for 3 seconds to turn off the robot.
3. Remove the screws at the bottom of the robot with a screwdriver, and remove the bumper and middle shell in turn.
4. Remove the motherboard and battery cover.
5. Press the clip to pull out the connector plug and remove the battery.

- When removing the battery, make sure that the battery is used up as much as possible and operate safely with power cut off.
- Please remove the whole battery pack together. Do not damage the battery pack shell to avoid short circuit or leakage of dangerous substances.
- If the battery has exudation and is accidentally touched, please wash it with plenty of water and seek medical advice in time.



Customer Service

Customer Service

We hope you love your robot as much as we love ours. If you need any further assistance please don't hesitate to contact us on 021-4742327.

Sincere Care, Always for You

- Customer service, warranty, tutorial video, FAQs
- Our latest events and news, more details

Warranty contents

This product is restricted to local selling, and the customer service and warranty regulations are applicable only to local customers. We provide warranty in accordance with the local warranty regulations. Any difference between the following warranty contents and local laws or regulations is subject to the construction or interpretation in local laws or regulations.

Type	Warranty contents	Warranty period
Robot	Robot (excluding its batteries, accessories and consumables)	1 year
Parts	Charging base, power cord, mop bracket	1 year
Battery	Robot battery	1 year

Note: Filter, roller brush, roller brush cover, side brush , dust bag and mop pad are consumables. We provide no warranty for the accompanying consumables.

None of the following circumstances is covered by the warranty. However, paid repair is available for such circumstances:

1. The user fails to operate the product in accordance with the instructions and causes damage due to improper storage;
2. The free warranty for the robot and its parts have expired;
3. It is damaged during disassembly by maintenance workers not authorized by us;
4. Unable to provide a valid purchase voucher number;
5. The model specified in the warranty card is inconsistent with the S/N of the product to be repaired or the model is altered;
6. Damage caused by irresistible factors such as natural disasters;
7. Product failure or damage caused by accidental factors or human factors (including operation error, liquid inlet, improper plugging, scratching, handling, collision, input of inappropriate voltage, etc.).



YOUR LOCAL FAMILY BUSINESS FOR SMART HOME SOLUTIONS

Experience the perfect blend of technology and convenience with our top-of-the-line robotic lawn mowers.



WIRE FREE
NO SET UP

BUDDY
From €970



SELF CHARGING
UP TO 500m2

CHOMPER
From €850

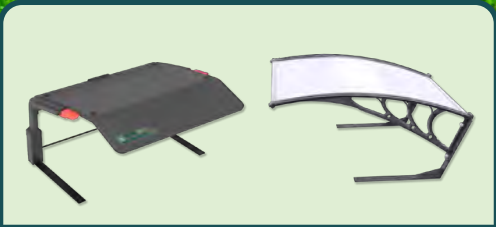

RAIN SHELTERS
Only €170

Scan to shop



CALL 021-4742327

Dunmanway, West Cork
www.homebotireland.ie

